

## Wiring



### WARNING

- When connecting the inverter to the power supply, add a circuit breaker for circuit protection and earth leakage breaker in the path of power supply.  
**Otherwise fire could occur.**
- Be sure to connect the grounding cable without fail.  
**Otherwise electric shock or fire could occur.**
- Both screws of grounding terminals of GVX1000-5.5/7.5-T has to be tightened up securely even if one grounding terminal is not used.  
**Otherwise electric shock or fire could occur.**
- Qualified electricians should carry out wiring.  
**Otherwise electric shock could occur.**
- Perform wiring after checking that the power supply is turned off.  
**Otherwise electric shock could occur.**
- Be sure to perform wiring after installing the main body of the inverter.  
**Otherwise electric shock or injuries could occur.**



### CAUTION

- Check that the number of phases and the rated voltage of the product agree with the number of phases and the voltage of the AC power supply.  
**Otherwise fire or an accident could occur.**
- Do not connect the AC power cables to the output terminals (U, V, W).  
**Otherwise fire or an accident could occur.**
- Do not connect a braking resistor directly to the DC terminals (P (+), N (-)).  
**Otherwise fire or an accident could occur.**
- The inverter, motor and wiring generate electric noise. Take care of malfunction of the nearby sensors and devices.  
**Otherwise an accident could occur.**

## Operation



### WARNING

- Be sure to install the terminal cover before turning the power on. Do not remove the cover during power application.  
**Otherwise electric shock could occur.**
- Do not operate switches with wet hands.  
**Otherwise electric shock could occur.**
- If the retry function has been selected, the inverter may automatically restart according to some causes after tripping.  
(Design the machine so that human safety is ensured after restarting).  
**Otherwise an accident could occur.**
- If the torque limit function has been selected, the inverter may operate at an acceleration/deceleration time or speed different from the set ones. Design the machine so that safety is ensured even in such cases.  
**Otherwise an accident could occur.**
- The STOP key is only effective when function setting has been established to make the STOP key enable. Prepare an emergency stop switch separately.  
**Otherwise an accident could occur.**
- If an alarm reset is made with the operation signal turned on, a sudden start will occur. Check that the operation signal is turned off in advance.  
**Otherwise an accident could occur.**
- Do not touch the inverter terminals during power applies to the inverter even if the inverter stops.  
**Otherwise electric shock could occur.**

**CAUTION**

- Do not turn the main circuit power on or off to start or stop inverter operation.  
**Otherwise failure could occur.**
- Do not touch the heat sink and braking resistor because they become very hot.  
**Otherwise burns could occur.**
- Setting the inverter to high speeds is easy. Check the performance of the motor and machines before changing the setting.  
**Otherwise injuries could occur.**
- The brake function of the inverter does not provide mechanical holding means.  
**Injuries could occur.**

**Maintenance and inspection and parts replacement****WARNING**

- Turn the power off and wait for at least five minutes before starting inspection.  
(Further, check that the charge lamp is unlit, and check the DC voltage across the P (+) and N (-) terminals to be lower than 25Vdc).  
**Otherwise electric shock could occur.**
- Maintenance and inspection and parts replacement should be made only by qualified persons.  
(Take off the watch, rings and other metallic matter before starting work).  
(Use insulated tools).  
**Otherwise electric shock or injuries could occur.**

**Disposal****CAUTION**

- Handle the inverter as an industrial waste when disposing of it.  
**Otherwise injuries could occur.**

**Others****WARNING**

- Never remodel.  
**Otherwise electric shock or injuries could occur.**

**GENERAL PRECAUTIONS**

Drawings in this manual may be illustrated without covers or safety shields for explanation of detail parts. Restore the covers and shields in the original state and observe the description in the manual before starting operation.

**Conformity to Low Voltage Directive in EU****[Available only for the products with CE or TÜV mark]****CAUTION**

1. Safe separation for control interface of this inverter is provided when this inverter is installed in overvoltage category II. PELV(Protective Extra Low Voltage) circuit or SELV(Safety Extra Low Voltage) circuit from external controller is connected to the interface directly.
2. Basic insulation for control interface of this inverter is provided when this inverter is installed in overvoltage category III. An insulation transformer has to be installed between power supply mains and this inverter when SELV circuit from external controller is connected to this inverter directly. Otherwise supplementary insulation between control interface of this inverter and environment must be provided.
3. The ground terminal G should always be connected to the ground. Don't use only RCD as the sole method of electric shock protection.  
Dimensions of external PE conductor should be same as dimensions of input phase conductor and capable for possible fault.
4. Use MCCB or MC that conforms to EN or IEC standard.
5. Where RCD (Residual-current-operated protective device) is used for protection in case of direct or indirect contact, only **RCD of type B** is allowed on the supply side of this EE (Electric equipment). Otherwise another protective measure shall be applied such as separation of the EE from the environment by double or reinforced insulation or isolation of EE and supply system by the transformer.
6. The inverter has to be installed in environment of pollution degree 2. If the environment is pollution degree 3 or 4, the inverter has to be installed in a cabinet of IP54 or higher.
7. Use a prescribed wire according to the EN60204 Appendix C.
8. Install the inverter, AC or DC reactor, input or output filter in an enclosure that meets the following requirement, to prevent a human body from touching directly to these equipment.
  - 1) When a person can touch easily on each connecting terminal or live parts, install the inverter, AC or DC reactor, output filter in an enclosure with minimum degree of protection of IP4X.
  - 2) When a person can not touch easily on each connecting terminal or live parts, install the inverter, AC or DC reactor, output filter in an enclosure with a minimum degree of protection of IP2X.
9. It is necessary to install the inverter in appropriate method using an appropriate RFI filter to conform to the EMC directive. It is customer's responsibility to check whether the equipment ,the inverter is installed in, conforms to EMC directive.
10. Do not connect copper wire to grounding terminal directly. Use clamp terminal with tin or equivalent plating to reduce electrochemical potential.
11. Do not remove the keypad panel before disconnecting power and do not insert/remove the extension cable for keypad panel remote operation while power is on. Confirm that the extension cable is securely latched to keypad panel and inverter before power is on.  
A supplementary isolation is required for the extension cable when the inverter is installed in overvoltage category III.
12. Basic insulation for control interface of this inverter is provided when the inverter is used at altitude over 2000m. The use at altitude over 3000m is not permitted.
13. The supply mains neutral has to be earthed for GVX1000

**Caution for UL/cUL requirement [Available only for the products with UL/cUL mark]**

1. [WARNING] Take care of electric shock. Be sure to turn the inverter off before starting work.
2. [CAUTION] When the charge lamp is lit, the inverter is still charged at a dangerous voltage.
3. [WARNING] There are two or more live parts inside the inverter.
4. The inverter is approved as a part used inside a panel. Install it inside a panel.
5. Perform wiring to the input, output and control terminals of the inverter, referring to the table below. Use UL certified round crimp terminal to the input and output terminals with insulation cover or covered with reduced tube to obtain the insulation distance. Use a crimping tool recommended by the terminal manufacturer when fabricating crimp terminals.
6. Install a fuse or circuit breaker between the power supply and the inverter, referring to the table below.

Inverter type	Tightening torque [Nm]		Applicable wire diameter [AWG] (mm <sup>2</sup> ) <sup>1)</sup>		Fuse <sup>2)</sup> [A]	Breaker [A]
	L1/R,L2/S, L3/T L1/L, L2/N P1,P(+) DB,N(-) U, V, W	Control section	L1/R,L2/S, L3/T L1/L, L2/N ⊕G P1,P(+) DB,N(-) U, V, W	Control section		
GVX1000-0.1-S	1.2	0.4	14 (2.1)	20 (0.5)	6	5
GVX1000-0.2-S					6	5
GVX1000-0.4-S					10	10
GVX1000-0.75-S	1.8		15		15	
GVX1000-1.5-S			12 (3.3)		30	30
GVX1000-2.2-S			10 (5.3)		40	40
GVX1000-0.4-T	1.8	0.4	14 (2.1)	20 (0.5)	6	5
GVX1000-0.75-T					10	10
GVX1000-1.5-T					15	15
GVX1000-2.2-T					20	20
GVX1000-4.0-T					3.5	12 (3.3)
GVX1000-5.5-T	10 (5.3)		40			40
GVX1000-7.5-T						

1) Use copper wires of allowable maximum temperature 60 or 75 degree C.

2) Use UL certified AC600V "Class J fuse."

7. The inverters GVX1000-0.1 to 2.2-S are suitable for use on a circuit capable or delivering not more than 20,000 rms symmetrical amperes, 240V maximum.
8. The inverters GVX1000-0.4 to 7.5-T are suitable for use on a circuit capable or delivering not more than the following symmetrical amperes, 480V maximum.  
When the fuse is installed : 20,000A  
When the circuit breaker is installed : 5000A
9. GVX1000 is an open type inverter.
10. A class 2 circuit wired with class 1 wire.

<b>1. Before Using the Inverter</b> ..... 1	<b>7. Troubleshooting</b> .....63
1-1 Receiving Inspection ..... 1	7-1 When Protective Function Goes
1-2 External view of Product..... 1	Active .....63
1-3 Handling the Product.....3	7-2 When Motor rotates Incorrectly.....67
1-4 Transportation ..... 6	<b>8. Maintenance and Inspection</b> .....71
1-5 Storage ..... 6	8-1 Daily Inspection.....71
<b>2. Installation and Connection</b> ..... 7	8-2 Periodic Inspection.....71
2-1 Operating Environment ..... 7	8-3 Measurement of Electrical Amounts
2-2 Installation Method ..... 7	in Main Circuit .....74
2-3 Connection ..... 8	8-4 Insulation Test.....75
2-3-1 Basic Connection..... 8	8-5 Replacement Parts .....75
2-3-2 Connection of Main Circuit and	8-6 Inquiries about Product and
Grounding Terminal ..... 10	Guarantee .....75
2-3-3 Connection of Control Terminal.... 12	<b>9. Specifications</b> .....76
2-3-4 Terminal Layout ..... 15	9-1 Standard Specifications .....76
2-3-5 Applicable Devices and	9-2 Common Specifications .....78
Cable Sizes for Main Circuit ..... 17	9-3 External Dimensions .....82
<b>3. Operation</b> ..... 18	9-4 RS485 Communication.....86
3-1 Inspection and Preparation	9-4-1 Connector and Communication
Before Operation ..... 18	Cable .....87
3-2 Operation Method..... 18	9-4-2 Recommended RS-232C/RS485
3-3 Test Operation..... 18	Converter.....87
<b>4. Keypad Panel</b> ..... 19	9-4-3 Remote/local changeover .....87
4-1 Appearance of Keypad Panel ..... 19	9-4-4 Communication Protocol.....88
4-1-1 Upon an Alarm..... 21	9-4-5 Standard Frame .....89
4-1-2 Digital Frequency Setting Method 21	9-4-6 Short Frame .....90
<b>5. Selecting Functions</b> ..... 22	9-4-7 Details of Frame.....91
5-1 Function Selection List ..... 22	9-4-8 Broadcasting .....92
5-2 Detail Description of Each Function .... 32	9-4-9 Communication Error Code .....93
Fundamental Functions (F Functions) .... 32	9-4-10Data Type.....93
Extension Terminal Functions (E Functions)	9-4-11Function Code List .....94
..... 42	9-4-12Data Format .....98
Control Functions of Frequency	<b>10. Options</b> .....102
(C Functions)..... 47	10-1 External Options.....102
Motor Parameters (P Functions)..... 50	<b>11. Applicable Reactor</b> .....103
High Performance Functions (H Functions)	<b>12. Electromagnetic compatibility</b> .....104
..... 52	12-1 General .....104
Alternative Motor Parameters (A Functions)	12-2 Recommended Installation Instructions
..... 60	..... 104
Optional Functions (O Functions) ..... 60	12-2-1 Single phases filter dimensions ...105
<b>6. Protective Operation</b> ..... 61	12-2-2 Three phases filter dimensions ....106
6-1 List of Protective Operations ..... 61	
6-2 Alarm Reset..... 62	

# 1. Before Using the Inverter

## 1-1 Receiving Inspection

Unpack and check the following items.

If you have any problems with the product, contact the dealer or the nearest branch of Bonfiglioli Riduttori div. Silectron sistemi.

- (1) Check the ratings nameplate to confirm that the delivered product is the ordered one.

**TYPE:** Type of inverter

GVX1000-5.5-T

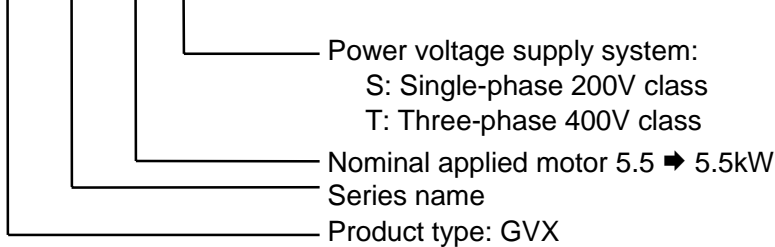

Bonfiglioli Group		Silectron sistemi	
TYPE			
SOURCE	3PH	V	50/60Hz
OUTPUT	3PH	kW	V 0.2-400Hz A
	150%	1min	
SER.NO.			
Manufactured by Fuji Electric Co.,Ltd		Made in Japan	

**SOURCE:** Number of input phases, input voltage, input frequency, input current

**OUTPUT:** Number of output phases, rated output capacity, rated output voltage, output frequency range, rated output current, overload current rating

**SER. NO.:** Product number

- (2) Check for breakage, missing parts, and dents or other damage on the cover and the main body given during transportation.
- (3) Instruction manual for inverter body is built-in.

## 1-2 External view of Product

- (1-1) Overall view (4.0kW or below)

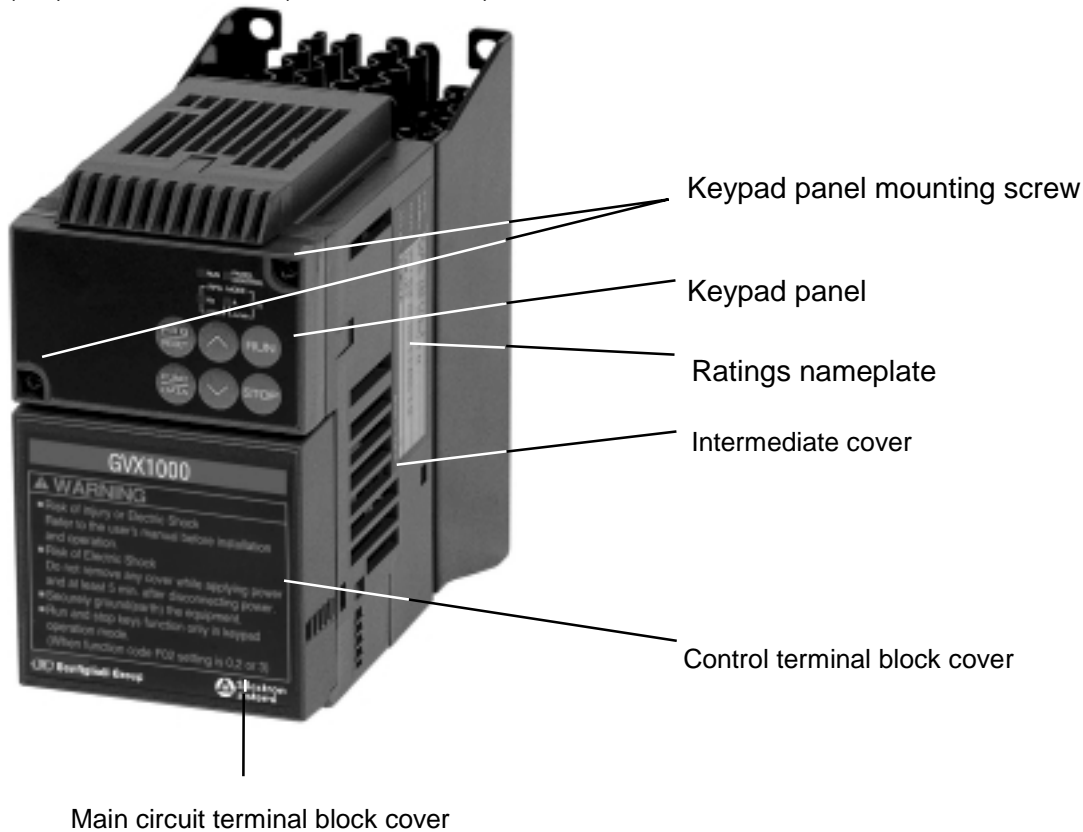

(1-2) Overall view (5.5, 7.5kW)

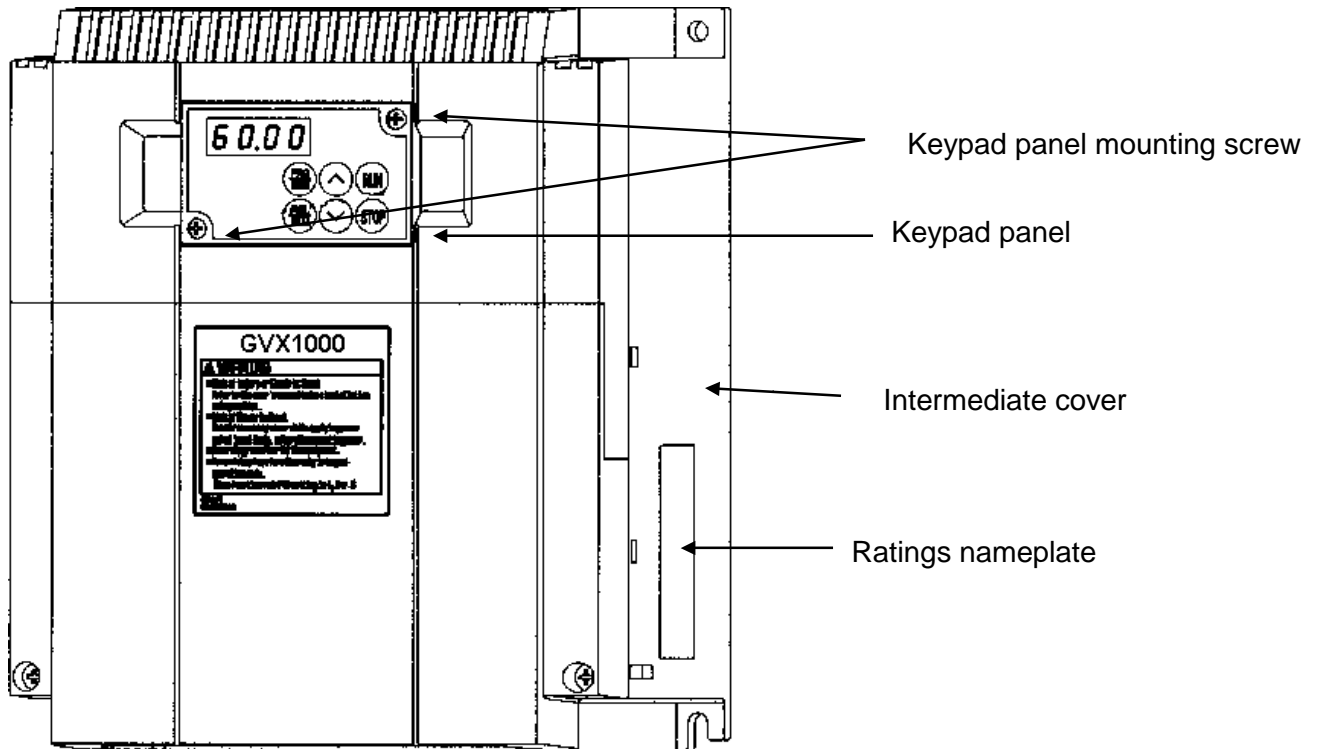

(2-1) View of wiring part (4.0kW or below)

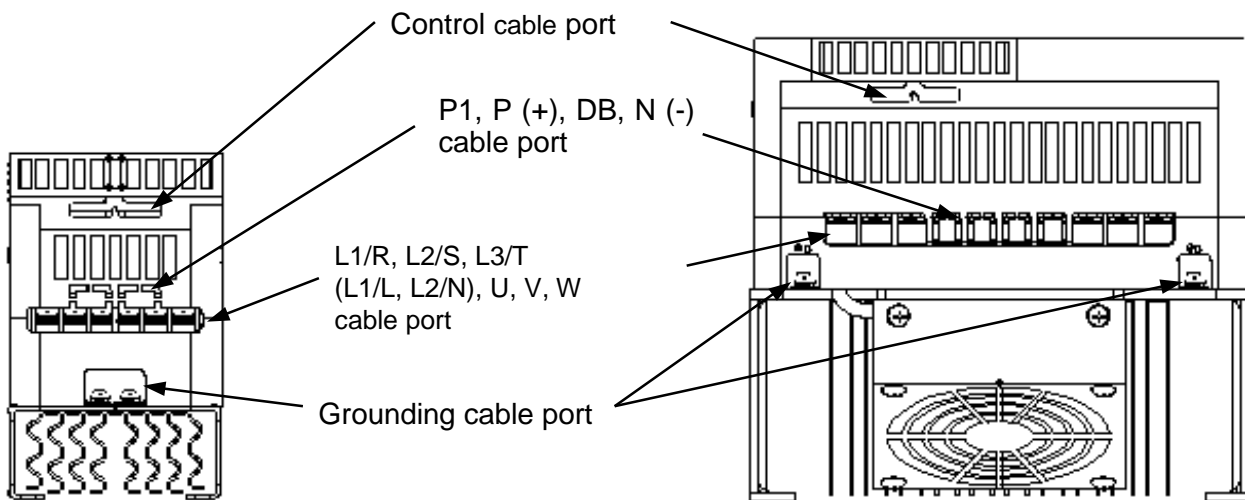

A barrier is provided in the main circuit terminal block cover for the P1, P (+), DB and N (-) cable port. Cut the barrier using nippers or the like before wiring.

(2-2) View of wiring part (5.5, 7.5kW)

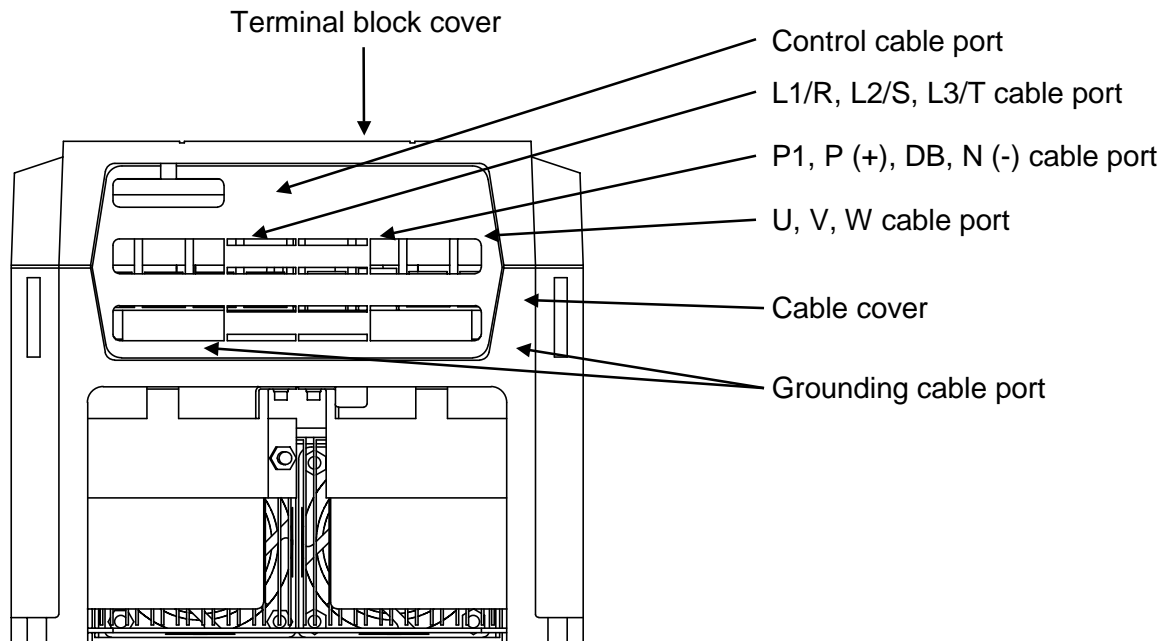

A barrier is provided in the cable cover for the P1, P (+), DB and N (-) cable port. Cut the barrier using nippers or the like before wiring.

### 1-3 Handling the Product

(1) Removing the control terminal block cover (4.0kW or below)

While lightly pushing the sides of the control terminal block cover at the catches, lift the cover in the procedure shown in Fig. 1-3-1 to remove it.

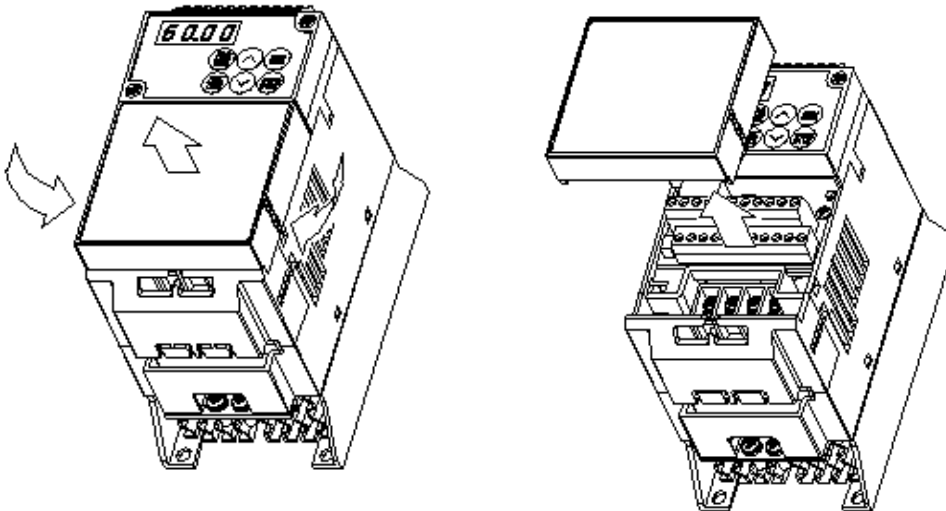

Fig. 1-3-1 Removing the control terminal block cover



(2) Removing the main circuit terminal block cover (4.0kW or below)

While lightly pushing the sides of the main circuit terminal block cover at the catches, slide toward you in the procedure shown in Fig. 1-3-2 to remove it.

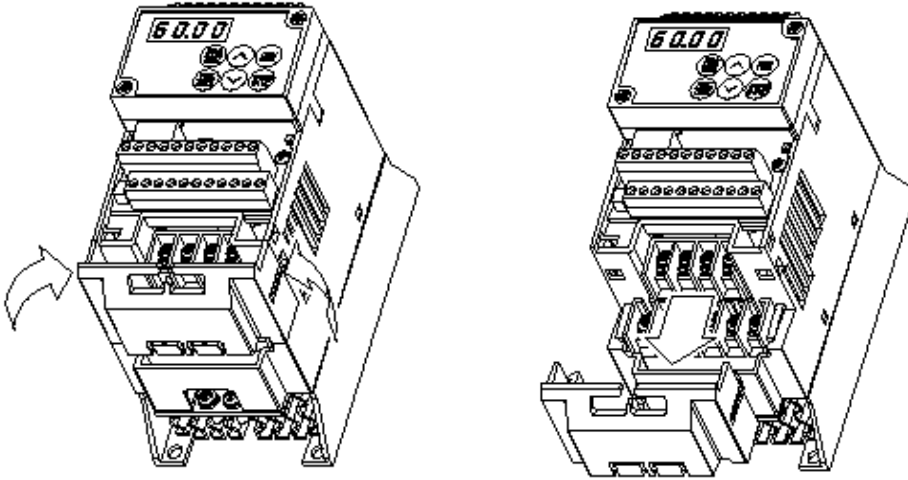
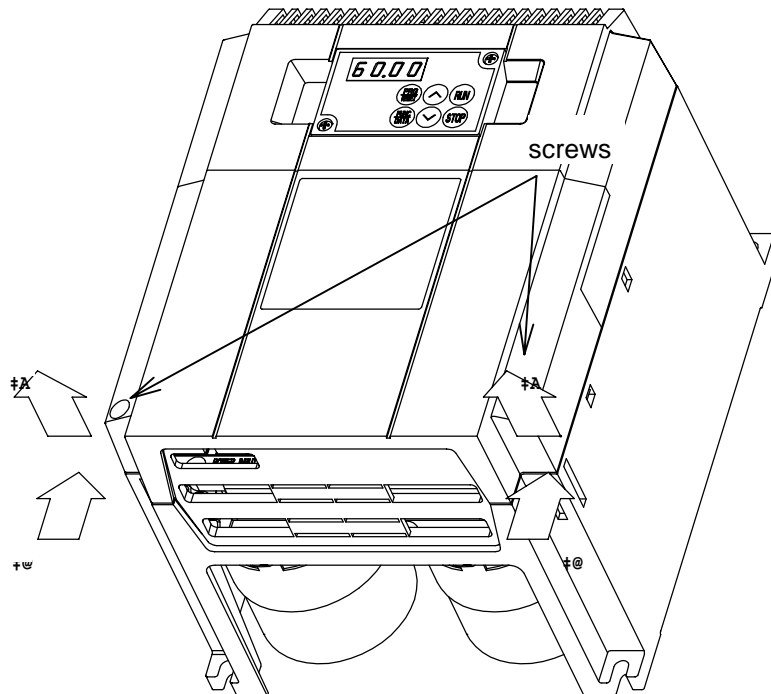

Fig. 1-3-2 Removing the main circuit terminal block cover

(3) Removing the terminal block cover (5.5,7.5kW )

Loose the screws indicated below and while lightly pushing the sides of the terminal block cover at the catches, lift the cover in the procedure shown in Fig. 1-3-3 to remove it.



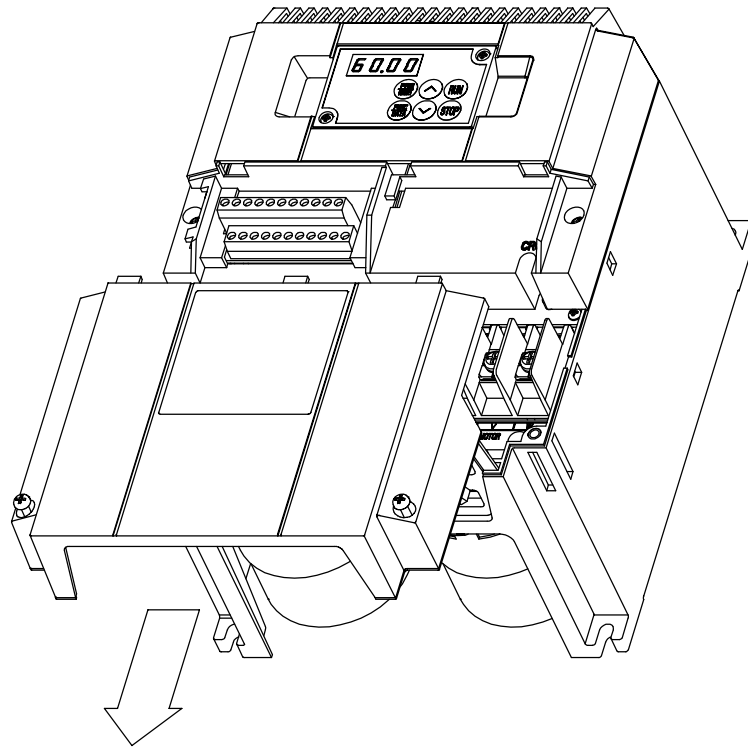

Fig. 1-3-3 Removing the terminal block cover

(4) Removing the keypad panel

Loosen the keypad panel mounting screws and remove the keypad panel in the procedure shown in Fig. 1-3-4. During the procedure, slowly remove the keypad panel right toward the top. If the keypad panel is handled abruptly, the connector will be broken.

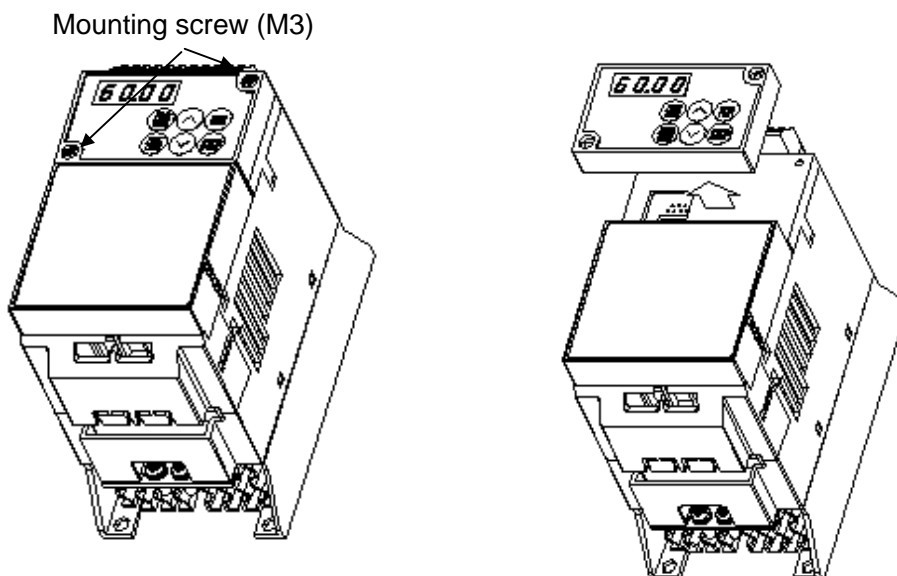

Fig. 1-3-4 Removing the keypad panel

Reverse the procedures to mount the terminal block cover and keypad panel.

#### 1-4 Transportation

Always hold the main unit when carrying the inverter.  
If covers or parts are held, the inverter may be broken or it may drop.

#### 1-5 Storage

##### **To store temporarily**

Store the inverter in an environment described in Table 1-5-1.

Table 1-5-1 Storage environment

Item	Specifications	
Ambient temperature	-10~+50 degree C	Places not subjected to abrupt temperature changes or condensation or freezing
Storage temperature <sup>(Note 1)</sup>	-25~+65 degree C	
Relative humidity	5~95% <sup>Note 2</sup>	
Atmosphere	The product must not be exposed to dust, direct sunlight, corrosive or flammable gases, oil mist, vapor, water drops or vibration. There must be little salt in the atmosphere.	
Atmospheric pressure	86~106kPa (During storage)	
	70~106kPa (During transportation)	

Note 1: The storage temperature is for a short time during transportation or the like.

Note 2: Even if the humidity is within the requirements of the specifications, places with abrupt temperature changes are subject to condensation or freezing. Avoid storing the inverter in such places.

- (1) Do not place the inverter directly on the floor.
- (2) If the ambient atmosphere is adverse, wrap the inverter in a vinyl sheet or the like when storing.
- (3) If humidity may give an ill effect, add a drying agent (such as silica gel) in the package prepared as described in item (2).

##### **To store for a long time**

The long-term storage method of the inverter varies largely according to the environment of the storage site. General storage methods are described below.

- (1) The storage site must satisfy the requirements of specifications for temporary storage.  
However, for storage exceeding three months, the upper limit of the ambient temperature shall not exceed 30 °C. This is for the prevention of deterioration of electrolytic capacitors left turned off.
- (2) The package must be air tight so that moisture will not enter. Add a drying agent inside the package to contain the relative humidity inside the package within 70%.
- (3) The inverter installed on a unit or control panel and left is likely to be exposed to moisture and dust. If this is the case, remove the inverter and move it to a preferable environment.
- (4) Electrolytic capacitors left turned off for an extended period of time deteriorate. Do not store for one year or more without turning the power on.

## 2. Installation and Connection

### 2-1 Operating Environment

Install the inverter in an environment described in Table 2-1-1.

Table 2-1-1 Operating environment

Item	Specifications
Site	Indoors
Ambient temperature	-10 to +50 degree C
Relative humidity	5 to 95% (without condensation)
Atmosphere	The inverter must not be exposed to dust, direct sunlight, corrosive gases, oil mist, vapor or water drops. There must be little salt. No condensation occurs due to abrupt temperature changes.
Altitude	1,000 m max. (Refer to Table 2-1-2 for altitudes exceeding 1000 m).
Atmospheric pressure	86 to 106 kPa
Vibration	3mm      2 to 9 Hz 9.8m/s <sup>2</sup> 9 to 20 Hz 2m/s <sup>2</sup> 20 to 55 Hz 1m/s <sup>2</sup> 55 to 200 Hz

Table 2-1-2 Output attenuation ratio in relation to altitude

Altitude	Output current attenuation ratio
1000 m or less	1.00
1000-1500m	0.97
1500-2000m	0.95
2000-2500m	0.91
2500-3000m	0.88

### 2-2 Installation Method

- (1) Tightly mount the inverter in the upright position on a rigid structure so that the "GVX1000" characters face front. Avoid mounting the inverter upside down or avoid mounting horizontally.
- (2) Allow clearances for cooling wind shown in Fig. 2-2-1 to cool down the inverter which generates heat during operation. The generated heat is radiated upward. Do not install the inverter below a heat sensitive device.
- (3) The temperature of the heat sink rises to about 90 °C during operation of the inverter. Mount the inverter on a base made of a material withstanding the temperature rise.

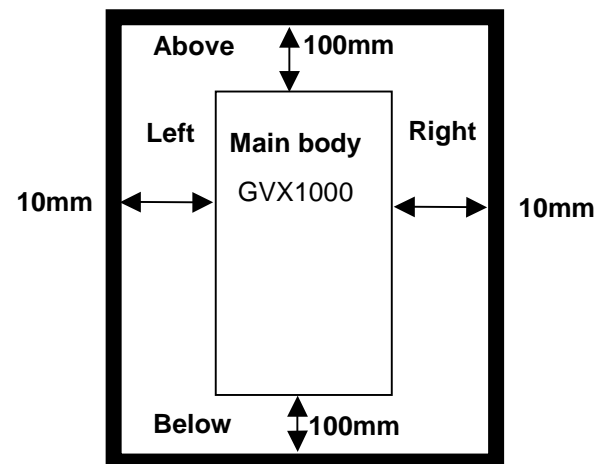



Fig. 2-2-1

 <b>WARNING</b>	Install the inverter on a non flammable material such as metal. <b>Otherwise fire could occur.</b>
--	---

- (4) When installing the inverter inside a control panel or the like, take full consideration for ventilation so that the ambient temperature of the inverter does not exceed the specification requirements. Do not install the inverter in a poorly ventilated small enclosure.
- (5) When storing multiple inverters inside a single unit or inside a control panel, horizontal installation is recommended to reduce mutual temperature effects. When an vertical layout is adopted for an unavoidable reason, install a partition plate or the like between inverters to isolate the heat of the lower inverter.

 <b>CAUTION</b>	Do not allow lint, paper, wood chips, dust, metallic chips or other foreign matter in the inverter or do not allow them attached to the heat sink. <b>Otherwise fire or an accident could occur.</b>
--	---

**2-3 Connection**

Remove the control terminal block cover to connect the control terminal block. Remove the main circuit terminal block cover to connect the main circuit terminal block. Correctly connect cables taking care of the following precautions.

**2-3-1 Basic Connection**

- (1) Be sure to connect the power cables to main circuit power terminals L1/R, L2/S and L3/T or L1/L,L2/N of the inverter. If the power cables are connected to other terminals, the inverter will be broken. As well, check the source voltage for the allowable voltage range specified on the nameplate and so on.
- (2) Connect the grounding terminal without fail according to national or local electric code to prevent electric shock, fire or other disasters and to reduce electric noise.
- (3) Use reliable crimp terminals for connection of cables to the terminals.
- (4) After finishing wiring, check the following.
  - a. Check if the cables are connected correctly.
  - b. Check if there is no failure of connection.
  - c. Check if terminals or cables are short circuited or there is a ground fault.
- (5) To change connection of an inverter having been turned on

The smoothing capacitor in the direct current part of the main circuit takes time to be discharged after it is turned off. To avoid danger, check the DC voltage (across main circuit terminals P (+) and N (-)) for a safety voltage (25 Vdc or lower) using a multi-meter, after the charge lamp is unlit. Wait until the residual voltage is discharged before shorting a circuit, to avoid being hit by sparks caused by the voltage (electric charge).

 <p><b>WARNING</b></p>	<ul style="list-style-type: none"> <li>• Be sure to connect the grounding cable without fail. <b>Otherwise electric shock or fire could occur.</b></li> <li>• Qualified electricians should carry out wiring. <b>Otherwise electric shock could occur.</b></li> <li>• Perform wiring after checking that the power supply is turned off. <b>Otherwise electric shock could occur.</b></li> </ul>
---	--

Basic connection diagram

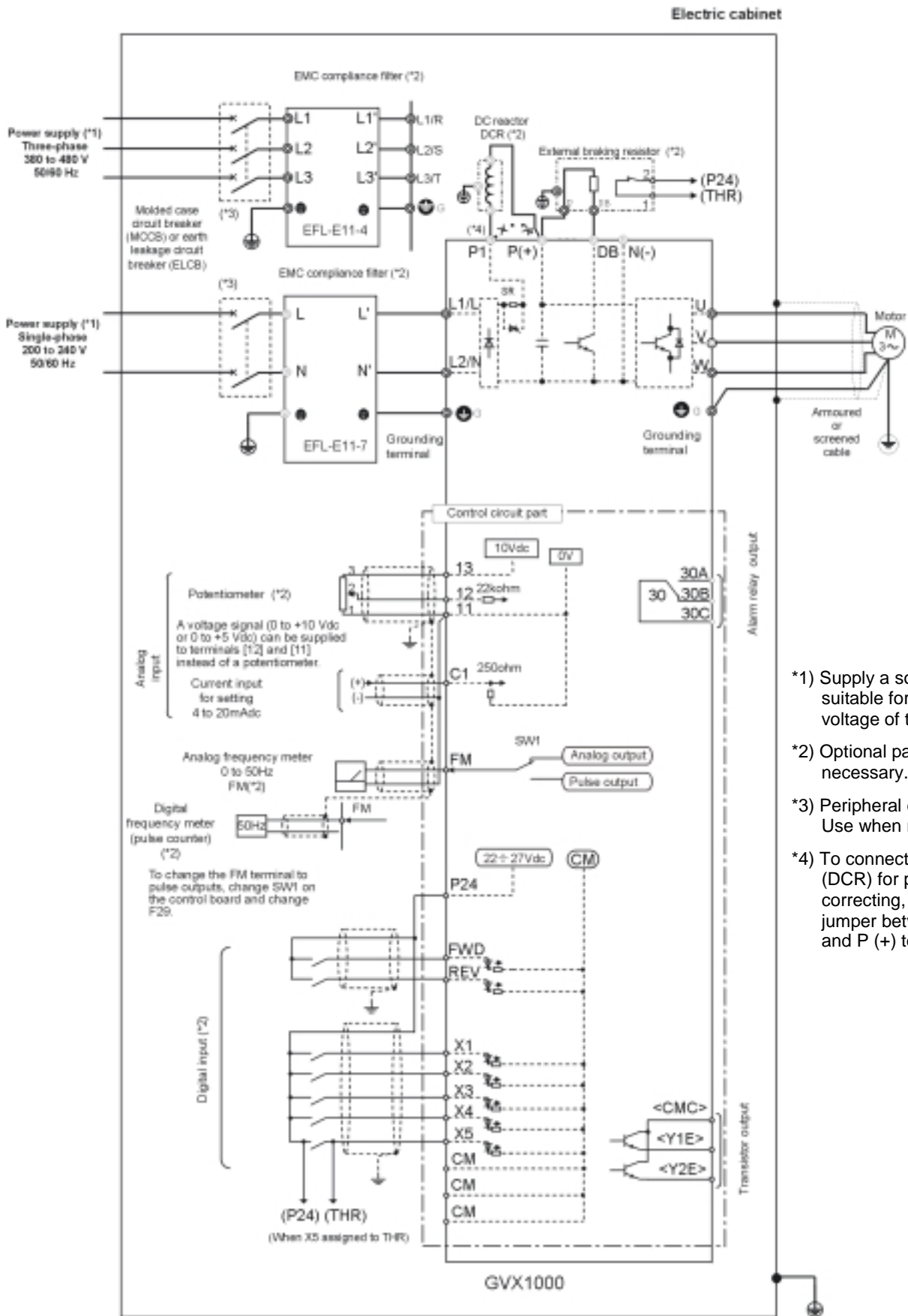

- \*1) Supply a source voltage suitable for the rated voltage of the inverter.
- \*2) Optional part. Use when necessary.
- \*3) Peripheral equipment. Use when necessary.
- \*4) To connect a DC reactor (DCR) for power factor correcting, remove the jumper between the P1 and P (+) terminals.

### 2-3-2 Connection of Main Circuit and Grounding Terminal

Table2-3-1 Connection of Main Circuit and Grounding Terminal

Symbol	Name of terminal	Description
L1/R,L2/S,L3/T	Main circuit power input	Connects a 3-phase power supply.
L1/L,L2/N	Main circuit power input	Connects a 1-phase power supply.
U,V,W	Inverter output	Connects a 3-phase induction motor.
P1,P(+)	For DC reactor	Connects an optional DC reactor.
P(+),DB	For external braking resistor	Connects an optional external braking resistor.
P(+),N(-)	DC link circuit terminal	Connected to DC link circuit.
 G	grounding	Grounding terminal of the inverter chassis (housing). Connect to the protective ground.

- (1) Main circuit power input terminal (L1/R, L2/S, L3/T,L1/L,L2/N)
  - a. Connect the main circuit power input terminals to the power supply through a circuit breaker for circuit (wiring) protection or an earth leakage breaker. There is not need to match the phase sequence.
  - b. It is recommended to connect a magnetic contactor to disconnect the inverter from the power supply to prevent a failure or accident from becoming serious upon activation of the protective function of the inverter.
  - c. Do not turn the main circuit power supply on or off to start or stop the inverter. Instead, use control circuit terminals FWD and REV or the RUN and STOP keys on the keypad panel. If it is unavoidable to turn the main circuit power supply on or off to start or stop the inverter, limit the frequency to once an hour or fewer.
  - d. Do not connect to a single-phase power supply for 3-phase input inverter.
- (2) Inverter output terminals (U, V, W)
  - a. Connect these terminals to a 3-phase motor with the correct phase sequence. If the direction of rotation does not match the operation direction, change arbitrary two cables among the U, V and W phases.
  - b. Do not connect a phase advance capacitor or surge absorber to the inverter output.
  - c. If the wiring length between the inverter and the motor is extremely long, the stray capacity between cables causes a high frequency current, possibly tripping the inverter due to an overcurrent, increasing the leakage current, or deteriorating the current detection accuracy to cause deterioration of the performance or other phenomena. To prevent such trouble, limit the wiring length of the motor to 50 m for 4.0 kW or a smaller output or to 100 m for a larger output.

Note: When a thermal relay is installed in the path between the inverter and the motor, or especially in the case of a 400V system, the thermal relay may malfunction even with a wiring length shorter than 50 m. In such a case, add an OFL filter or lower the Motor sound adjustment (carrier frequency function code F26)

## (3) DC reactor connecting terminals (P1, P (+))

- a. Use this terminal to connect a DC reactor (option).  
Remove the jumper connected in the factory before connecting the DC reactor.
- b. Do not remove the jumper if no DC reactor is used.  
Cut the barrier in the main circuit terminal block cover for the P1, P (+), DB and N (-) cable port using nippers or the like when connecting wiring.

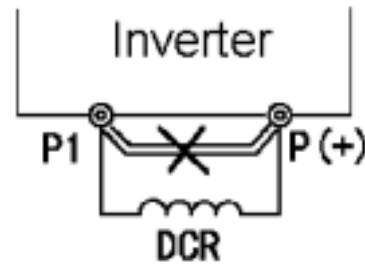

Fig. 2-3-1 DCR connection diagram

## (4) External braking resistor connecting terminals (P (+), DB)

GVX1000 is not equipped with a braking resistor. An external braking resistor (option) is necessary for frequent operation or heavy duty inertia load operation to enhance the braking performance.

- a. Connect the P (+) and DB terminals of the external braking resistor to the P (+) and DB terminals of the inverter.
- b. Arrange devices so that the wiring length is within 5 m and twist or closely (in parallel) place the two cables.

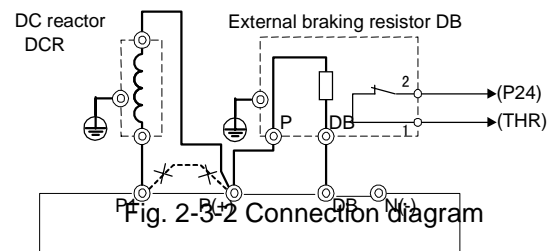

Fig. 2-3-2 Connection diagram

## (5) Inverter grounding terminal (⊕G)

Ground the grounding terminal ⊕G for safety and noise reduction without fail. The metallic frame of electrical equipment must be grounded in accordance with national or local electric code to avoid electric shock, fire and other disasters.

**CAUTION**

- Check that the number of phases and the rated voltage of the product agrees with the number of phases and the voltage of the AC power supply.
- Do not connect the AC power cables to the output terminals (U, V, W).  
**Otherwise injuries could occur.**
- Do not connect a braking resistor directly to the DC terminals (P (+), N (-)).  
**Otherwise fire could occur.**



**2-3-3 Connection of Control Terminal**

Table 2-3-2 shows the functions of the control circuit terminals. The method of connecting control function terminals varies according to the function setting. Refer to the connection method for the function.

Table 2-3-2 Functions of control circuit terminals

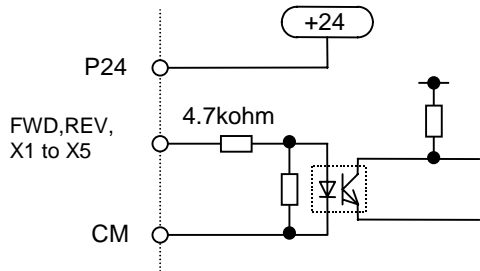
Classification	Terminal symbol	Terminal name	Description of function																								
Analogue input	13	Potentiometer power supply	+10 Vdc power supply for frequency setting POT. (POT: 1 to 5 kΩ).																								
	12	Voltage input	(1) The frequency is set according to the external analogue input voltage command. <ul style="list-style-type: none"> <li>• 0 to +10 Vdc / 0 to 100%</li> <li>• Reversible operation using +/- signal: 0 to +/-10 Vdc / 0 to 100%</li> <li>• Inverse mode operation: +10 to 0 Vdc / 0 to 100%</li> </ul> (2) The PID control feedback signal is input. * Input resistance: 22 kΩ																								
	C1	Current input	(1) The frequency is set according to the analogue input current command. <ul style="list-style-type: none"> <li>• 4 to 20 mAdc / 0 to 100%</li> <li>• Inverse mode operation: 20 to 4 mAdc / 0 to 100%</li> </ul> (2) The PID control feedback signal is input. * Input resistance 250 ohm																								
	11	Common	Common for analogue signals																								
Digital input	FWD	Forward operation command	Forward operation with FWD-P24 ON and deceleration and stop with FWD-P24 OFF.																								
	REV	Reverse operation command	Reverse operation with REV-P24 ON and deceleration-stop with REV-P24 OFF.																								
	X1	Digital input 1	A coast-to-stop command from an external device, external alarm, alarm reset, multi-step frequency selection and other functions can be assigned to the X1 through X5 terminals. Refer to the terminal function E01 to 05 setting method in section 5-2 Detail Description of Each Function. <Digital input circuit specification>																								
	X2	Digital input 2																									
	X3	Digital input 3																									
	X4	Digital input 4																									
	X5	Digital input 5																									
			<table border="1"> <thead> <tr> <th colspan="2">Item</th> <th>min.</th> <th>typ.</th> <th>Max.</th> </tr> </thead> <tbody> <tr> <td rowspan="2">Operation voltage</td> <td>Level OFF</td> <td>0V</td> <td>-</td> <td>2V</td> </tr> <tr> <td>Level ON</td> <td>22V</td> <td>24V</td> <td>27V</td> </tr> <tr> <td colspan="2">Operation current at ON</td> <td>-</td> <td>4.2mA</td> <td>6mA</td> </tr> <tr> <td colspan="2">Allowable leakage current at OFF</td> <td>-</td> <td>-</td> <td>0.5mA</td> </tr> </tbody> </table>	Item		min.	typ.	Max.	Operation voltage	Level OFF	0V	-	2V	Level ON	22V	24V	27V	Operation current at ON		-	4.2mA	6mA	Allowable leakage current at OFF		-	-	0.5mA
	Item		min.	typ.	Max.																						
Operation voltage	Level OFF	0V	-	2V																							
	Level ON	22V	24V	27V																							
Operation current at ON		-	4.2mA	6mA																							
Allowable leakage current at OFF		-	-	0.5mA																							
																											
	P24	Control unit power supply	+24V DC power supply for control input. Maximum output current : 50mA																								
	CM	Common	Common for digital input																								

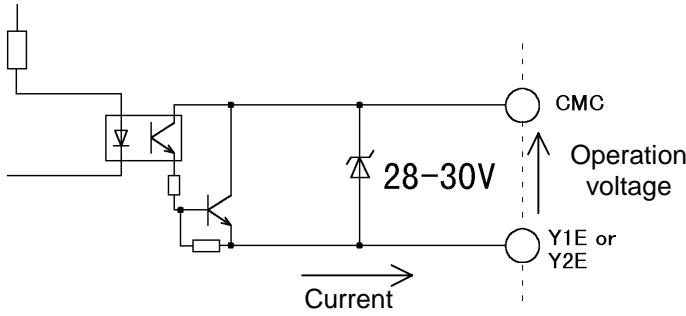
Classification	Terminal symbol	Terminal name	Description of function																								
Analogue output / pulse output	FM (11: Common terminal)	Analogue monitor	<p>The monitor signal for analogue DC voltage (0 to +10 Vdc) is output. The signal description can be selected from the following.</p> <ul style="list-style-type: none"> <li>• Output frequency1 (before slip compensation)</li> <li>• Output frequency2 (after slip compensation)</li> <li>• Output current</li> <li>• Output torque</li> <li>• Input power</li> <li>• DC link circuit voltage</li> <li>• Output voltage</li> <li>• Load factor</li> <li>• PID feedback value</li> </ul> <p>* Allowable connection impedance: min. 5 kΩ</p>																								
		Pulse rate monitor	<p>The monitor signal is output according to the pulse voltage. The signal description is the same as the FMA signal.</p> <p>* Allowable connection impedance: min. 5 kΩ</p> <p>Use SW1 on the control board and function code F29 to change between the analogue monitor and Pulse rate monitor.</p> <p>(FMA: analogue monitor, FMP: Pulse rate monitor)</p>																								
Transistor output	Y1E	Transistor output 1	<p>The RUN signal, frequency equivalence signal, overload early warning signal and other signals are output to arbitrary ports at a transistor output. Refer to terminal function E20 to 21 setting methods in section 5-2 Detail Description of Each Function.</p> <p>&lt;Transistor output circuit specification&gt;</p> <table border="1"> <thead> <tr> <th colspan="2">Item</th> <th>min.</th> <th>typical</th> <th>max.</th> </tr> </thead> <tbody> <tr> <td rowspan="2">Operation voltage *1</td> <td>OFF level</td> <td>-</td> <td>1V</td> <td>2V</td> </tr> <tr> <td>ON level</td> <td>-</td> <td>24V</td> <td>27V</td> </tr> <tr> <td colspan="2">Maximum load current at ON</td> <td>-</td> <td>-</td> <td>50mA</td> </tr> <tr> <td colspan="2">Leakage current at OFF</td> <td>-</td> <td>-</td> <td>0.1mA</td> </tr> </tbody> </table> 	Item		min.	typical	max.	Operation voltage *1	OFF level	-	1V	2V	ON level	-	24V	27V	Maximum load current at ON		-	-	50mA	Leakage current at OFF		-	-	0.1mA
	Item			min.	typical	max.																					
	Operation voltage *1	OFF level		-	1V	2V																					
		ON level		-	24V	27V																					
Maximum load current at ON		-	-	50mA																							
Leakage current at OFF		-	-	0.1mA																							
Y2E	Transistor output 2																										
CMC	Common (Transistor output)	Common for transistor output signal. Isolated from terminals CM and 11.																									
P24 (CM: common terminal)	DC voltage supply	Power supply for transistor output load. (24 Vdc 50 mAdc Max). When using P24, short the CMC and P24 terminals. If the P24 terminal is overloaded or connected with the CM terminal, the inverter trips with Er3 indication. To reset, remove external causes and, after several minutes, turn the inverter on again.																									
Relay output	30A,30B 30C	Alarm relay output	<p>When the inverter is stopped with an alarm, a relay contact output (1C) is issued.</p> <p>Contact capacity: 48 Vdc 0.5 A (When complying with UL/cUL:42Vdc 0.5A)</p> <p>Selection between excitation upon an alarm or excitation during normal operation is allowed.</p>																								

- (1) Analogue input terminals (13, 12, C1, 11)
  - a. Because weak analogue signals are handled, these signals are especially susceptible to the external noise effects. Route the wiring as short as possible (within 20 m) and use shielded cables. In principle, ground the shield of the shielded cable; if effects of external inductive noises are considerable, connection to terminal 11 may be effective.
  - b. Use twin contacts relay for weak signals if relay is used in the circuit. Do not add a contact to terminal 11.
  - c. When the inverter is connected with an external device outputting the analogue signal, a malfunction may be caused by electric noise generated by the inverter according to some type of the circuit of the device. If this happens, connect a ferrite core or capacitor to the device outputting the analogue signal.

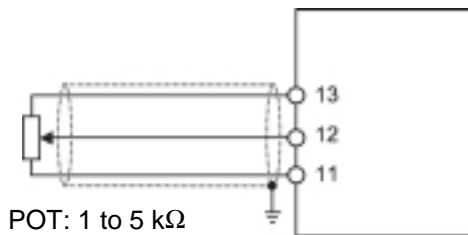

Fig. 2-3-3 Potentiometer connection

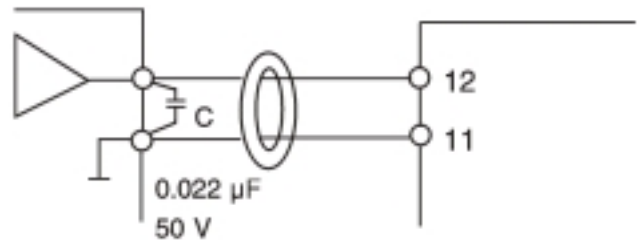



Fig. 2-3-4 Countermeasures against electric noise (example)

- (2) Digital input terminals (FWD, REV, X1 through X5, P24)
  - a. Generally the digital input terminals (FWD, REV, X1-5) are turned on or off in relation to the P24 terminal.
  - b. To use contact input, use a reliable contact free from poor contact.
- (3) Transistor output terminals (Y1E-Y2E, CMC)
  - a. Circuit configuration shown in Table 2-3-2 for transistor output is adopted. Take care of the polarity of the external power supply.
  - b. To connect a control relay, connect a surge absorbing diode across the coil of the relay.
- (4) Others
  - a. Route the wiring of the control terminals as far from the wiring of the main circuit as possible. Otherwise electric noise may cause malfunctions.
  - b. Fix the control cables inside the inverter to keep them away from the live parts of the main circuit (such as the terminal block of the main circuit).

 <b>WARNING</b>	If the control cables touch the live part of the main circuit, the insulation sheath of the control cable, insulation of which is not reinforced, may be broken to cause a high voltage of the main circuit to be fed to the control signal. This is banned in the low voltage directive models for Europe. <b>Electric shock could occur.</b>
 <b>CAUTION</b>	Electric noise may be generated by the inverter, motor or wiring. Take care of malfunctions of the nearby sensors and devices. <b>An accident could occur.</b>

**2-3-4 Terminal Layout**

(1) Main circuit terminal block

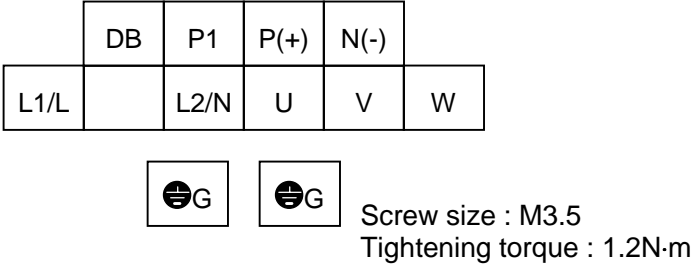
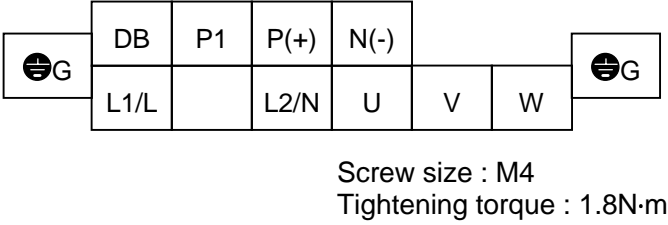
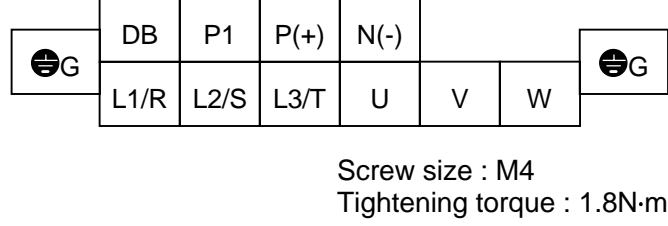
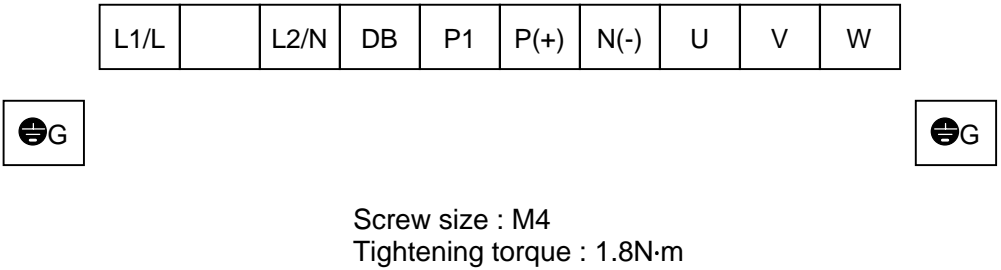
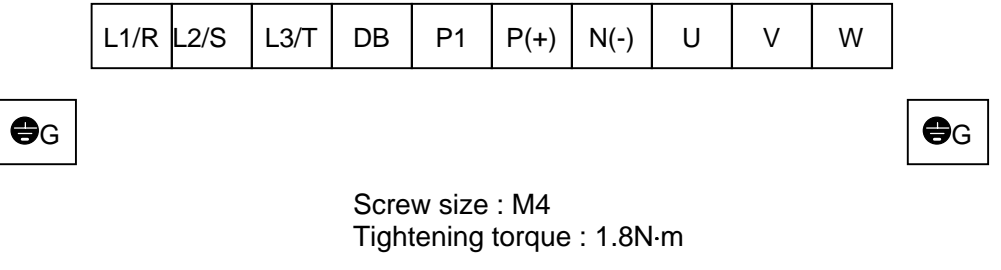
Inverter type	Main circuit terminal drawing
GVX1000-0.2-S GVX1000-0.4-S	 <p>Screw size : M3.5 Tightening torque : 1.2N·m</p>
GVX1000-0.75-S	 <p>Screw size : M4 Tightening torque : 1.8N·m</p>
GVX1000-0.4-T GVX1000-0.75-T GVX1000-1.5-T GVX1000-2.2-T	 <p>Screw size : M4 Tightening torque : 1.8N·m</p>
GVX1000-1.5-S GVX1000-2.2-S	 <p>Screw size : M4 Tightening torque : 1.8N·m</p>
GVX1000-4.0-T	 <p>Screw size : M4 Tightening torque : 1.8N·m</p>

(1) Main circuit terminal block (continued)

Inverter type	Main circuit terminal drawing
GVX1000-5.5-T GVX1000-7.5-T	<p style="text-align: center;">Screw size : M5 Tightening torque : 3.5N·m</p>

(2) Control terminal block

30A	30B	Y1E	C1	FM	X1	X2	X3	X4	X5	CM
30C	Y2E	CMC	11	12	13	CM	FWD	REV	CM	P24

Screw size: M2.5  
Tightening torque: 0.4N·m

### 2-3-5 Applicable Devices and Cable Sizes for Main Circuit

Table 2-3-4 Selection of peripheral devices

Inverter type	Nominal applied motor [kW]	Molded case circuit breaker (MCCB) or earth leakage circuit breaker (ELCB) * <sub>1</sub>		Recommended wire size [mm <sup>2</sup> ]				
				Input circuit* <sub>2</sub> [L1/R, L2/S, L3/T] [L1/L, L2/N] ⊕G		Output circuit* <sub>2</sub> [U, V, W]	DCR* <sub>2</sub> circuit [P1] [P(+)] DB	Control wiring
		Rated current [A]	With DCR	Without reactor* <sub>3</sub>	With DCR			
GVX1000-0.2-S	0.2	6	6	2.5	2.5	2.5	2.5	0.5
GVX1000-0.4-S	0.4		10					
GVX1000-0.75-S	0.75	16	4					
GVX1000-1.5-S	1.5	16	25	4	6	2.5 (DB) 4 (Others)	0.5	
GVX1000-2.2-S	2.2	25	32					
GVX1000-0.4-T	0.4	6	6	2.5	2.5	2.5	2.5	0.5
GVX1000-0.75-T	0.75		10					
GVX1000-1.5-T	1.5	16	4					
GVX1000-2.2-T	2.2	10	16	4	6	2.5	2.5	0.5
GVX1000-4.0-T	4.0							
GVX1000-5.5-T	5.5	16	25	4	6	2.5	2.5	0.5
GVX1000-7.5-T	7.5	20	32					

- \*1 The applicable frame and series of the model of the molded case circuit breaker (MCCB) and earth leakage breaker (ELCB) vary according to the capacity of the transformer of the equipment. For details of selection, refer to the concerning technical documents.
- \*2 The recommended cable size for the main circuit is the case for the use of the PVC cable at ambient temperature 40 degree C specified in Appendix C of EN 60204
- \*3 The power supply impedance without a reactor is considered to be the equivalent of 0.1% of the inverter capacity, with 10% current unbalance accompanied by the voltage unbalance.
- \*4 Up to crimp terminal with max. 7.4 mm width (including tolerance) can be used.
- \*5 Up to crimp terminal with max. 9.8 mm width (including tolerance) can be used.
- \*6 Use crimp terminals with an insulating cover.

### 3. Operation

#### 3-1 Inspection and Preparation Before Operation

Check the following before starting operation.

- (1) Check if connection is correct.  
Especially check if the power cables are connected to inverter output terminals U, V and W and that the grounding cable is grounded without fail.
- (2) Check for short circuits between terminals and exposed live parts and ground faults.
- (3) Check for loose terminals, connectors and screws.
- (4) Check if the motor is separated from mechanical equipment.
- (5) Turn the switches off so that the inverter does not start or operate erroneously at power-on.
- (6) After the power is turned on, check the following.
  - a. Check if the keypad panel shows an alarm.
  - b. Check if the fan built in the inverter rotates (1.5 kW or above).

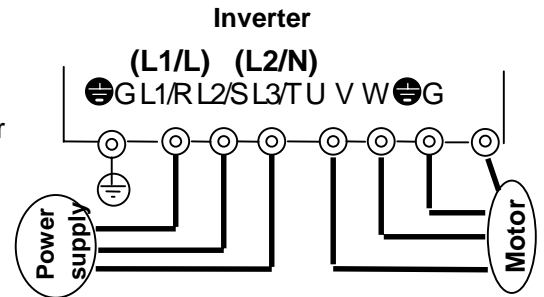

Fig. 3-1-1  
Inverter connection diagram

<b>WARNING</b>	<ul style="list-style-type: none"> <li>• Be sure to install the terminal cover before turning the power on. Do not remove the cover during power application. Do not operate switches with wet hands. <b>Otherwise electric shock could occur.</b></li> </ul>
----------------	---

#### 3-2 Operation Method

There are various operation methods. Refer to chapter 4 "Keypad Panel" and chapter 5 "Selecting Functions" to select the method most suitable for the purpose and operation specification. Table 3-2-1 shows general operation methods.

#### 3-3 Test Operation

After checking for errors in section 3-1, perform a test operation.

In the factory shipment state, the inverter is in the keypad panel operation mode.

- (1) Turn the power on and check that the LED blinks while indicating the 0.00 Hz frequency.
- (2) Using the key, set the frequency to a low frequency such as 5 Hz.
- (3) To turn forward: F02 = 2  
To reverse: F02 = 3  
After setting the above, press the key to start operation. To stop, press the key.
- (4) Check the following points.
  - a. Check if the direction of rotation is correct.
  - b. Check for smooth rotation without motor humming or excessive vibration.
  - c. Check for smooth acceleration and deceleration.
- (5) Referring to function code P04 Motor 1 (auto tuning), tune the motor constant.

When no abnormality is found, raise the operation frequency to check.

After checking for correct operation during the above test operation, start normal operation.

**Caution 1:** If any abnormality is found to the inverter or motor, immediately stop operation and determine the cause referring to chapter 7 Troubleshooting.

**Caution 2:** If voltage is applied to the L1/R, L2/S and L3/T or L1/L and L2/N main circuit power supply terminals even after the inverter stops, the inverter output terminals U, V and W are live and you will be hit by electric shock when touching the terminals. As well, the smoothing capacity is not discharged immediately after the power is turned off and it takes time for the capacitor to be discharged. To touch the electric circuit after turning the power off, check that the charge lamp is unlit and check for safe voltage using a multimeter.

Table 3-2-1 General operation methods

Operation method	Frequency setting	Operation command
Operation using keypad panel	Keypad panel keys ,	Keypad panel keys ,
Operation using external signal terminal	,	Contact input (switch), terminals FWD-P24, terminals REV-P24
	Potentiometer or analogue voltage, current or multistep speed operation	

### 4. Keypad Panel

The keypad panel is provided with various functions such as operation (frequency setting and start/stop commands) from the keypad panel, monitor and alteration of function code data, and various confirmation functions.

Be familiar with the operation method of each function before starting operation.

#### 4-1 Appearance of Keypad Panel

The diagram shows a keypad panel with a digital display and several buttons. Callouts provide detailed information about each function:

- ☆ Digital display**  
 Various function codes and data codes for programming are shown. The output frequency, output current and other data are displayed during operation, and the cause of a trouble is displayed using codes when protective function works.
- ☆ Unit and operation mode display**  
 The unit of the data displayed at the digital display is indicated with an LED. The program mode is indicated. The PANEL CONTROL lamp lights up in the keypad panel operation mode.
- ☆ RUN key**  
 Press this key to start operation. An LED lights up during operation. When data code  $F \square \square 0 \square 2 = \square \square \square \square 1$ , the key does not function.
- ☆ STOP key**  
 Press this key to stop operation. When data code  $F \square \square 0 \square 2 = \square \square \square \square 1$ , this key does not function.
- ☆ Up/down keys**  
 Press these keys to increase or decrease the frequency or speed. In the programming mode, use these keys to change the function code or data setting.
- ☆ Function/Data key**  
 Use this key to switch over between frequency display, output current display and other display in the regular operation mode. In the programming mode, use this key to retrieve or write various function codes and various function data.
- ☆ Program (PRG)/RESET key**  
 Press this key to switch over between the regular operation mode and programming mode. Use this key to reset an alarm stopping state after activation of a protective function.

#### (1) Monitor switching method

In the regular operation mode, press the **(FUNC DATA)** key to switch between frequency display, output current display and other display.

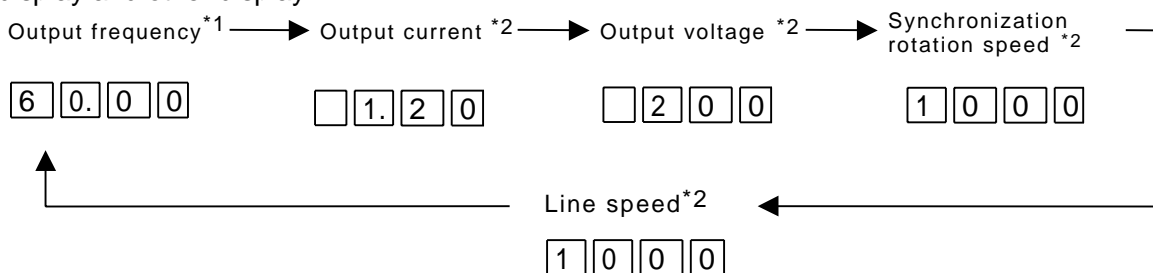

\*1: In the PID control mode (when function H20 is at "1" or "2"), the value is in the percent display and the dot at the least significant digit always lights up.

Example: 10%:  $\square 1 \square 0. \square$  ., 100%:  $\square 1 \square 0 \square 0.$

\*2: Press the **(Up/Down)** key during display of these data to display the frequency setting.



(2) Stopping operation

When  $F \square \square 0 \square 2$  is other than  $\square \square \square 1$  press  $\text{RUN}$  to start operation or press  $\text{STOP}$  to stop operation. The direction of rotation is as shown below.

$F \square \square 0 \square 2 = \square \square \square 0$  : Forward rotation with FWD-P24 ON, reverse rotation with REV-P24 ON

$F \square \square 0 \square 2 = \square \square \square 2$  : Forward rotation (Inputs at the FWD and REV terminals are ignored).

$F \square \square 0 \square 2 = \square \square \square 3$  : Reverse rotation (Inputs at the FWD and REV terminals are ignored).

(3) Changing the frequency

When  $F \square \square 0 \square 1$  is at  $\square \square \square 0$  , press the  $\text{▲}$  key to increase the frequency or press the  $\text{▼}$  key to decrease the frequency. Press and hold the  $\text{▲}$  or  $\text{▼}$  key and press the  $\text{FUNC DATA}$  key to increase the frequency change speed.

**Note) Do not turn the power off for five seconds after performing a monitor change or function setting. Otherwise Er1 will be caused.**

(4) Function setting method





	Description of operation	Operation procedure	Display result
0	Initial state		$5 \square 0. \square \square 0$
1	Start the program mode.	Press the $\text{PRG RESET}$ key.	$F \square \square 0 \square 0$
2	Select a setting or monitoring function.	Press the $\text{▲}$ or $\text{▼}$ key.	$F \square \square 0 \square 1$
3	Have the data displayed.	Press the $\text{FUNC DATA}$ key.	$\square \square \square 1$
4	Change the data.	Press the $\text{▲}$ or $\text{▼}$ key.	$\square \square \square 2$
5	Store the data.	Press the $\text{FUNC DATA}$ key.	$F \square \square 0 \square 2$
6	Exit from the program mode. (Or select another function).	Press the $\text{PRG RESET}$ key. (Press the $\text{▲}$ or $\text{▼}$ key).	$5 \square 0. \square \square 0$







(5) Changing the function code

The function code consists of an alphabetic character and a numeral. The alphabetic character is defined for each of the function groups.

Table 4-1-1 Major groups of function codes

Function code	Function
F00~F42	Fundamental functions
E01~E41	Extension terminal functions
C01~C33	Control functions of frequency
P01~P10	Motor parameters
H01~H46	High performance functions
A01~A19	Alternative motor parameters



The function code changes each time the  or  key is pressed. (Press and hold the  or  key to continue to change the function code).

While pressing and holding the  or  key during function code change, press the  key to change to the next group with another alphabetic character. (Press the  and  keys to jump to the top of the F, E, C, P, H or A code, or press the  and  key to jump to the last of the F, E, C, P, H or A code).

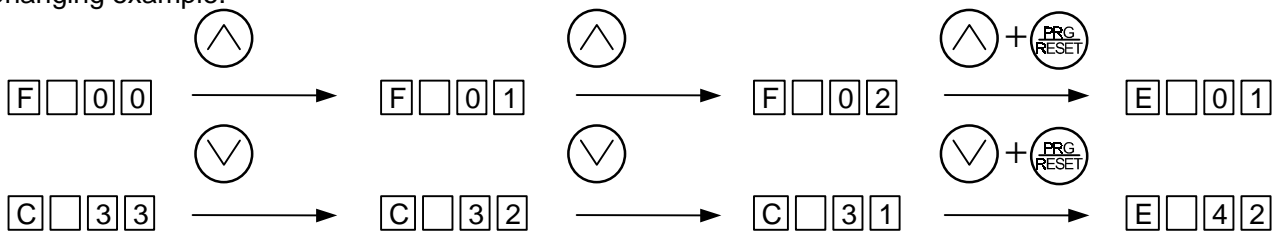
Changing example:









4-1-1 Upon an Alarm

When an alarm occurs, the description of the alarm is displayed. Press the  or  key during alarm display to display the latest three alarms.

To display previous 4 alarms, select function . (Refer to H02 Trip history).

4-1-2 Digital Frequency Setting Method

Press the  or  key at the operation mode screen. The LED display changes to the frequency setting, and the data increases or decreases in the unit of the least increment first. While the  or  key is held down, the changing digit moves to the upper order for fast changes. Further, while pressing and holding down the  or  key, press the  key to increase the changing speed further. No special operation is necessary to store the new frequency setting. The setting is automatically stored when the inverter is turned off.

## 5. Selecting Functions

### 5-1 Function Selection List

Table 5-1-1 Function selection list

#### F: Fundamental functions

Function code	Name	Setting range	Min. unit	Factory setting	Change during operation	RS485 Data format	User setting
F00	Data protection	0: Data change enabled 1: Data protected	1	0	×	0	
F01	Frequency command 1	0: Keypad operation 1: Voltage input (terminal 12) 2: Current input (terminal C1) 3: Voltage and current input 4: Voltage input with polarity (terminal 12) 5: Voltage input inverse mode operation (terminal 12) 6: Current input inverse mode operation (terminal C1) 7: UP/DOWN control mode 1 8: UP/DOWN control mode 2	1	0	×	0	
F02	Operation method	0: Keypad operation (direction of rotation: input at terminal block) 1: External signal (digital input) 2: Keypad operation (forward rotation) 3: Keypad operation (reverse rotation)	1	2	×	0	
F03	Maximum frequency 1	50 to 400 Hz	1Hz	50	×	0	
F04	Base frequency 1	25 to 400 Hz	1Hz	50	×	0	
F05	Rated voltage 1 (at Base frequency1)	0V: Voltage proportional to the source voltage is output. 80 to 240V (200V class) 160 to 480V (400V class)	1V	230 400	×	0	
F06	Maximum voltage 1 (at Maximum frequency 1)	80 to 240V (200V class) 160 to 480V (400V class)	1V	230 400	×	0	
F07	Acceleration time 1	0.01 to 3600 s	0.01s	6.00	○	6	
F08	Deceleration time 1	0.01 to 3600 s	0.01s	6.00	○	6	
F09	Torque boost 1	0: Automatic torque boost 1: Square reduction torque characteristics 2: Proportional torque characteristics 3 to 31: Constant torque characteristics	1	0	○	0	
F10	Electronic thermal overload relay for motor 1 (Select)	0: Inactive 1: Active (for general purpose motors) 2: Active (for forced-ventilated motors)	1	1	△	0	
F11	(level)	20 to 135% of the rated inverter current	0.01A	4 pole motor rated motor current	○	6	
F12	(Thermal time constant)	0.5 to 10.0 min.	0.1min	5.0	○	2	

Description of change during operation

○: The data changed by the ▲ or ▼ key takes effect on the inverter operation. However, press the  key to store the new data.

△: Press the ▲ or ▼ key to change the data. The new data takes effect after the  key is pressed to store the data.

X: The data can be changed only while the inverter is stopped.

Function code	Name	Setting range	Min. unit	Factory setting	Change during operation	RS485 Data format	User setting
F13	Electronic thermal overload relay (for braking resistor)	0: Inactive 1: Active (for external braking resistor) 2: Active (for large external braking resistor)	1	0	X	0	
F14	Restart mode after momentary power failure	0: Inactive (The inverter immediately trips upon power failure). 1: Inactive (The inverter trips after the power failure is recovered). 2: Active (The inverter restarts at the frequency effective at the time of power failure). 3: Active (The inverter restarts at the starting frequency).	1	0	X	0	
F15	Frequency limiter (High)	0 to 400 Hz	1Hz	70	○	0	
F16	(Low)			0	○	0	
F17	Gain (For frequency setting signal)	0.0 to 200.0%	0.1%	100.0	○	2	
F18	Bias frequency	-400 to +400Hz	1Hz	0	○	1	
F20	DC brake (Starting frequency)	0.0 to 60.0Hz	0.1Hz	0.0	○	2	
F21	(Braking level)	0 to 100%	1%	0	○	0	
F22	(Braking time)	0.0 s (Inactive) 0.1 to 30.0s	0.1s	0.0	○	2	
F23	Starting frequency (Freq.)	0.1 to 60.0Hz	0.1Hz	0.5	X	2	
F24	(Holding time)	0.0 to 10.0s	0.1s	0.0	X	2	
F25	Stop frequency	0.1 to 6.0Hz	0.1Hz	0.2	X	2	
F26	Motor sound (Carrier frequency)	0.75,1 to 15kHz	1kHz	15	○	0	
F27	(Sound tone)	0 to 3	1	0	○	0	

○: The data changed by the ▲ or ▼ key takes effect on the inverter operation. However, press the  key to store the new data.

△: Press the ▲ or ▼ key to change the data. The new data takes effect after the  key is pressed to store the data.

X: The data can be changed only while the inverter is stopped.